

GV-QR1352 / DES1352 Reader & Mobile Access Control

User's Manual



- GV-QR1352 / DES1352 Reader
- GV-Mobile Card
- GV-Mobile Access App

Before attempting to connect or operate this product, please read these instructions carefully and save this manual for future use.



© 2022 GeoVision, Inc. All rights reserved.

Under the copyright laws, this manual may not be copied, in whole or in part, without the written consent of GeoVision.

Every effort has been made to ensure that the information in this manual is accurate. GeoVision, Inc. makes no expressed or implied warranty of any kind and assumes no responsibility for errors or omissions. No liability is assumed for incidental or consequential damages arising from the use of the information or products contained herein. Features and specifications are subject to change without notice.

GeoVision, Inc.
9F, No. 246, Sec. 1, Neihu Rd.,
Neihu District, Taipei, Taiwan
Tel: +886-2-8797-8377
Fax: +886-2-8797-8335
<http://www.geovision.com.tw>

Trademarks used in this manual: *GeoVision*, the *GeoVision* logo and *GV* series products are trademarks of GeoVision, Inc. *Windows* is the registered trademark of Microsoft Corporation.

April 2022

Scan the following QR codes for product warranty and technical support policy:



[Warranty]



[Technical Support Policy]

Preface

Welcome to the *GV-QR1352 / DES1352 & Mobile Access Control User's Manual*.

This Manual covers the following three topics:

GV-QR1352, GV-DES1352 reader.
GV-Mobile Card
GV-Mobile Access App

Contents

Preface	1
Contents	2
Chapter 1 GV-QR1352 / DES1352	4
1.1 Packing List	5
1.2 Compatible Products	6
1.3 Terminal Blocks and Switches	7
1.4 Installation	8
1.5 Connect the Reader to GV-AS Controller	9
1.5.1 Connect through Wiegand Interface	9
1.5.2 Connect through RS-485 Interface	10
1.5.3 Define Readers on GV-AS Controller Web Interface	11
1.6 Set up the ID, Beeper or LED	13
1.7 Activate Beeper or LED upon Controller's Output Trigger	15
1.7.1 Wiring	16
1.7.2 Define Output Conditions	17
1.8 The Number of Readers Supported by Controllers	18
Chapter 2 Mobile Cards and Mobile App	19
2.1 Download Mobile Cards	20
2.2 Assign Mobile Cards to Users	21
2.3 Activate Mobile Cards	23
2.3.1 Through E-Mail	23
2.3.2 Scan a QR Code on GV-ASManager	24
2.4 Mobile Card Managements	25
2.4.1 Query and Combine Serial Keys	25
2.4.2 Revoke Mobile Cards	26
2.5 GV-Mobile Access App	27

2.5.1 Edit the Card	27
2.5.2 Backup and Restore	28
Chapter 3 Visitor QR Codes	29
QR Code Comparison	31
Troubleshooting	32

Chapter 1 GV-QR1352 / DES1352

GV-QR1352 is a QR code and RFID card reader; **GV-DES1352** is a RFID card reader. The two readers accept dual-band frequency access cards (125 kHz EM and 13.56 MHz Mirfare), and their Weigand interfaces allow for integration with any standard access control systems.

Not only can GV-QR1352 detect RFID tags, but it can also read QR codes on smartphones to unlock doors as part of the *GeoVision mobile access solution*.

QR Code Functions



GV-QR1352 can read two different types of QR codes for various access control applications. One is visitor access QR codes issued by *GV-ASManager's Visitor Management System (GV-VMWeb)*. The other is mobile access QR codes created by *GV-Mobile Access app*. The mobile access QR codes represents a virtual access card, named *GV-Mobile Card*, for regular or visitor access management.

The first type of QR code for visitor access control is supported by all GeoVision Wiegand controllers. However, in order to offer QR code access with *GV-Mobile Access app*, **GV-QR1352** must be connected to the controllers *GV-AS210 / 2110 / 2120, GV-AS410 / 4110 / 4111, or GV-1620 via RS-485 interfaces*.

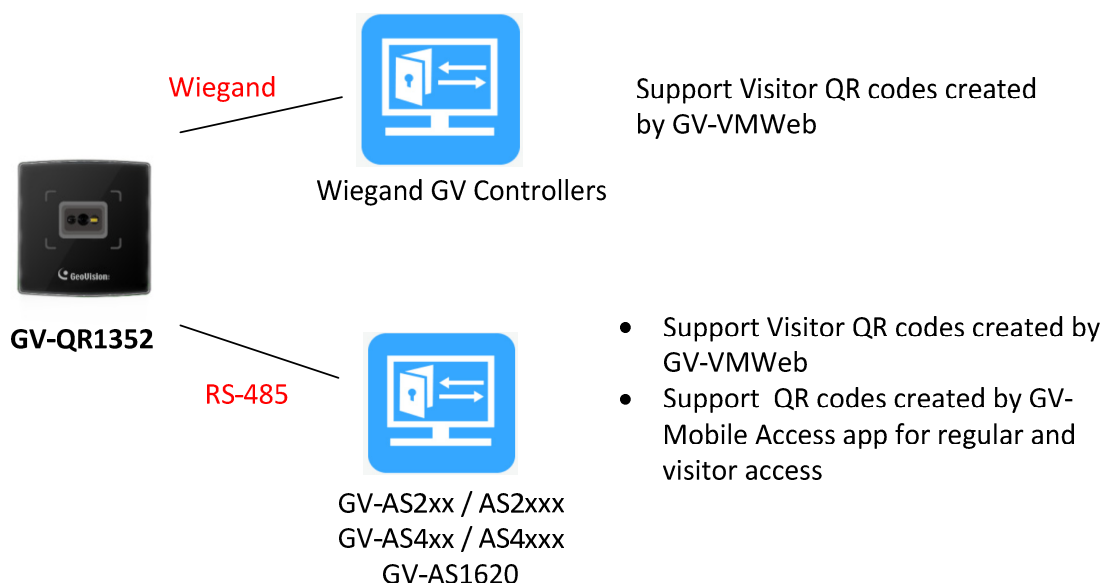
The following diagram illustrates the QR code applications with GeoVision controllers.

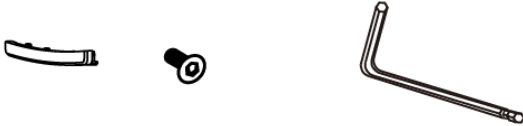
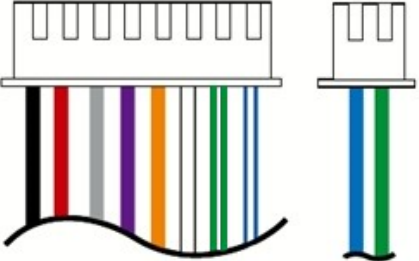

1.1 Packing List

<p>1. GV-QR1352/ GV-DES1352 (US / EU)</p> 	<p>2. Bottom Cover 3. Hex Socket Flat Head Cap Screw (M3 x 8) x 2 4. Allen Key (2 mm, 48 x 15 mm)</p> 
<p>5. Terminal Cable x 2</p> 	<p>6. Mounting Plate (US / EU)</p> 
<p>7. Heightening Mount Bracket (US)</p> 	

1.2 Compatible Products

GV-DES1352

- **GV-ASManager**
- **GV-AS Controllers:** GV-AS210 / 2110 / 2120, GV-AS810 / 8110 / 8111, GV-AS410 / 4110 / 4111, GV-1620

Note: To connect GV-DES1352 to GV-AS Controllers *via RS-485*, it is required to use the following products and versions: GV-AS210 / 2110 / 2120 / 410 / 4110 / 4111 V2.40 (or later) and GV-AS1620 V1.04 (or later).

GV-QR1352

The following products and versions are required to support *Visitor QR codes* issued by *GV-VMWeb*:

- **GV-ASManager:** V5.3.3 or later
- **GV-AS Controllers:** GV-AS210 / 2110 / 2120, GV-AS810 / 8110 / 8111, GV-AS410 / 4110 / 4111, GV-1620

The following products and versions are required to support *dynamic QR codes* created by *GV-Mobile Access app*:

- **GV-ASManager:** V5.3.3 or later
- **GV-AS210 / 2110 / 2120, GV-AS410 / 4110 / 4111:** V2.40 or later
- **GV-AS1620:** V1.04 or later

The following products and versions are required to support *Visitor QR codes* created by *GV-Mobile Access app*:

- **GV-ASManager:** V6.0.0 or later
- **GV-AS210 / 2110 / 2120, GV-AS410 / 4110 / 4111:** V2.50 or later
- **GV-AS1620:** V1.10 or later
- **GV-QR1352:** V1.10 or later

1.3 Terminal Blocks and Switches

2-Pin Terminal Block

No	Wire Color	Function
1	Green	RS-485 -
2	Blue	RS-485+

8-Pin Terminal Block

No	Wire Color	Function
1	Blue + White	Wiegand 1
2	Green + White	Wiegand 0
3	White	Reserved
4	Orange	Red LED
5	Purple	Green LED
6	Gray	Beeper
7	Red	DC 12V
8	Black	Ground

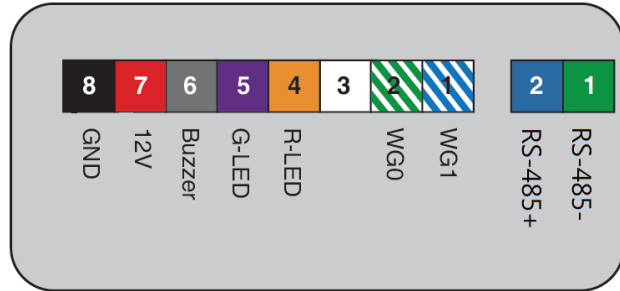

Switches for DESfire Card Support

By default, GV-QR1352 / GV-DES1352 support dual-band frequency. To only support DESFire 13.56MHz cards, turn **ON** on the switch No 1.

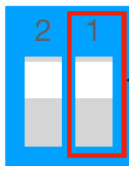
	No	ON/OFF	Note
	1	ON: Enable the support OFF: Disable the support (Default)	Every time when the setting is changed, the reader needs to be restarted to apply the change.
2	Reserved		

Note: GV-DESFire cards contain two types of ID: UID and DES ID. When only DES ID is required, turn on the switch No. 1.

1.4 Installation

1. Pull the terminal cables from the square holes of the mounting plate **B**.
2. Secure **B** onto the wall with self-prepared Flat Head Cap Philips Tapping Screws.
 - For users of US gang boxes, mount **B** with the heightening mount bracket before the following steps.



3. Connect the cables to the backside of the body **C**, and attach **C** to **B** at lower position of **B**. Push **C** up to make both hooked completely.
4. Use the supplied Allen key and 2 screws to assemble the body **C** onto the mounting plate **B**.
5. Attached the supplied back cover **D** to **C**.
6. Once the reader is powered on, its beeper will sound. Wait for the reader to start for 10 sec.

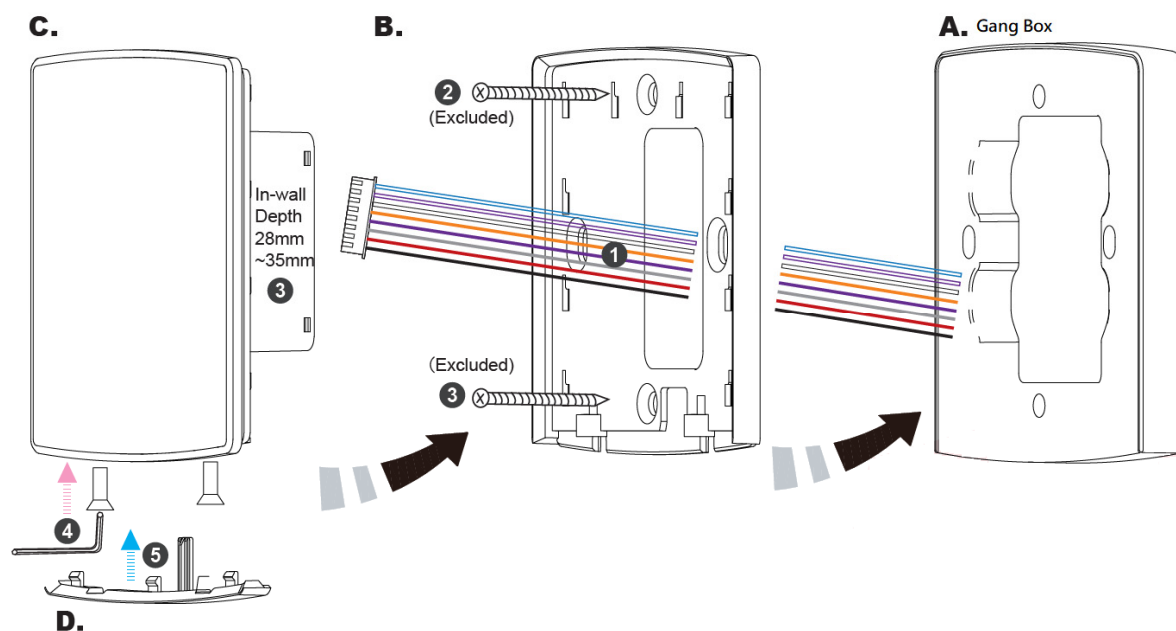

1.5 Connect the Reader to GV-AS Controller

You can connect the readers to GV-AS Controller through Wiegand or RS-485 interfaces. Note that the connection between the reader and GV-AS Controller varies with different controller models. To see how many readers can be connected to a GV-AS Controller, refer to *1.7 The Number of Readers Supported by Controllers*.

Note: Each GV-QR1352 / DES1352 consumes 85mA of power. The total power consumption of the output devices and readers connected to GV-AS Controller must be under **3A** (for GV-AS210 / 2110 / 2120), **3.5A** (for GV-AS410 / 4110 / 4111), **5A** (for GV-AS810 / 8110 / 8111), **3A** (for GV-AS1620). Connect an external power supply if the power supplied from GV-AS Controller is insufficient.

1.5.1 Connect through Wiegand Interface

The following diagrams use GV-AS410 Controller as an example. Up to eight readers can be connected to GV-AS410 through the controller's Wiegand interfaces.

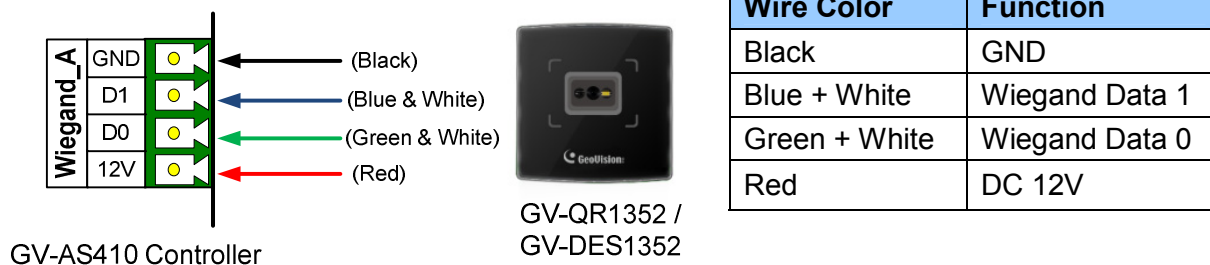

1.5.2 Connect through RS-485 Interface

The following diagrams use GV-AS410 Controller as an example. Up to eight readers can be connected together to a single RS-485 interface on GV-AS410.

- Connecting four or less readers to GV-AS410 Controller:



- Connecting five or more readers to GV-AS410 Controller:
 For readers five to eight, wire RS-485 cables to the RS-485 interface on GV-AS410 and then wire the 12V power and GND cables of each reader to a 12V DC power output on the controller.

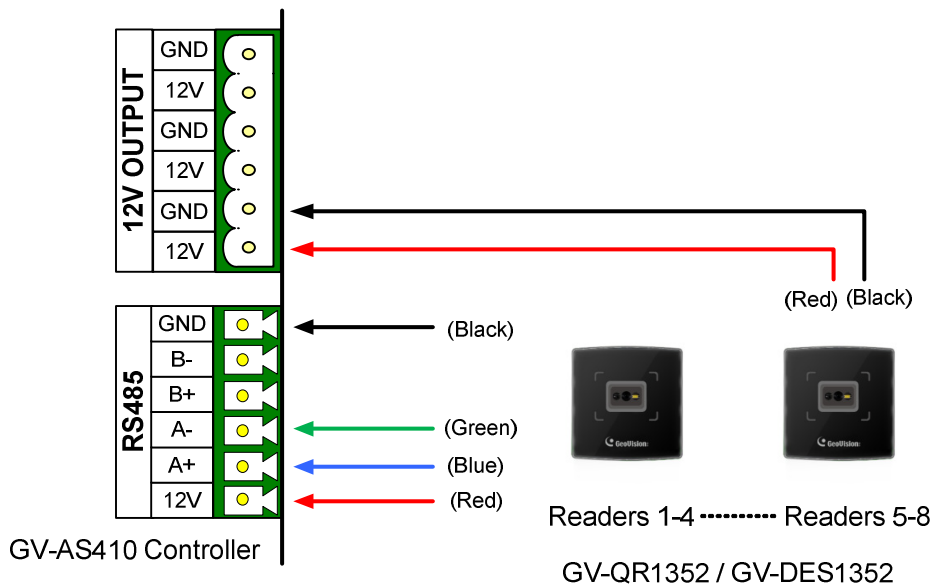

Note: When multiple readers are connected together, an extra power supply to each unit is required. Use 12V power output and GND on the power terminal to power on each unit.

1.5.3 Define Readers on GV-AS Controller Web Interface

When multiple readers connect to GV-AS Controller, you need to specify which door each reader controls. This section explains how to define readers on the Web interface of GV-AS Controller. Note that the Web interface of different GV-AS Controller models varies. Here we use GV-AS410 Web interface as an example.

Web Interface for RS-485 Readers

IMPORTANT: If you want to connect multiple RS-485 readers to the controller, it is required to set up the ID for each RS-485 reader in advance, see [1.5 Setting the ID, Beeper or LED](#) for details.

1. On the controller's Web interface, click **Extended Reader**. This dialog box appears.

Extended Reader Configuration

GV-Reader/CR1320/GF192x/DES1352/QR1352 Function

RS485 Protocol GV QR1352/DES1352

RS485	Serial Number	Function	Connection Status
<input type="checkbox"/>	ID 0 <input type="text"/>	No Function <input type="button" value="v"/>	
<input type="checkbox"/>	ID 1 <input type="text"/>	No Function <input type="button" value="v"/>	
<input type="checkbox"/>	ID 2 <input type="text"/>	No Function <input type="button" value="v"/>	
<input type="checkbox"/>	ID 3 <input type="text"/>	No Function <input type="button" value="v"/>	
<input type="checkbox"/>	ID 4 <input type="text"/>	No Function <input type="button" value="v"/>	
<input type="checkbox"/>	ID 5 <input type="text"/>	No Function <input type="button" value="v"/>	
<input type="checkbox"/>	ID 6 <input type="text"/>	No Function <input type="button" value="v"/>	
<input type="checkbox"/>	ID 7 <input type="text"/>	No Function <input type="button" value="v"/>	

Read Mode:

GeoFinger Server IP Address: . . . : (from 1025 to 65535)

2. Select **QR1352/DES1352**.
3. Based on the paired ID number set for the reader in advance, select the **RS485** checkbox.
4. From the **Function** drop-down list, select a door/gate to which the reader is connected.

5. Keep **Read Mode** as default.
6. Click **Submit**.

Note:

1. When you click **Submit** on the Extended Reader page of GV-210 / 2110 / 2120, GV-AS410 / 4110 / 4111, all readers connected through RS-485 interfaces will reboot.
 2. For GV-QR1352 / GV-DES1352, the Read Mode for UID and DES ID is set up using the switch on the reader. See 1.3 *Terminal Blocks and Switches*.
-

Web Interface for Wiegand Readers

1. On the controller's Web interface, click **Wiegand Configuration**. This dialog box appears.

Wiegand Configuration

Wiegand Function

Wiegand A: Door/Gate 1 Entry ●

Wiegand B: Door/Gate 1 Exit ●

Wiegand C: Door/Gate 2 Entry

Wiegand D: Door/Gate 2 Exit

Filter: Disable

Submit **Cancel**

2. Select a door/gate to which the reader is connected.
3. To prevent cards from being swiped multiple times consecutively, enable **Filter**.
4. Click **Submit**.

1.6 Set up the ID, Beeper or LED

The **GV-QR1352 / GV-DES1352 Setup AP** allows you to set the reader's ID number and beeper / LED. The program can be downloaded from our website.

You can connect up to 8 GV-QR1352 readers to a single RS-485 interface on the controller. For connecting multiple readers together, you need to set up a unique ID number for each reader in order for the controller to recognize them.

Note: The ID setting is only required for the reader connected through RS-485.

By default, when a card or QR code approaches GV-QR1352 / DES1352 (no matter it is granted or denied), the reader will beep. The setup AP allows you to change how GV-QR1352 / DES1352 reacts upon being approached, from a beep to a flashing red LED or green LED.

Note: The beep, LED settings are applicable to both the RS-485 and Wiegand readers.

Once you download and install the **GV-QR1352 / GV-DES1352 Setup AP** on a PC, GV-QR1352 / DES1352 needs to connect to a PC through a *RS-485 to USB converter*, e.g., GV-COM V3, as illustrated below.

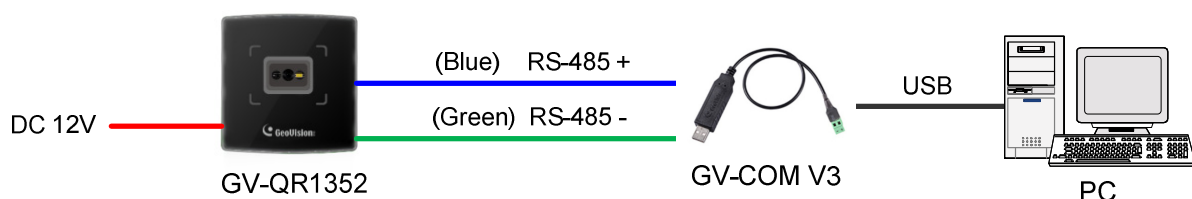

1. Run the setup AP.

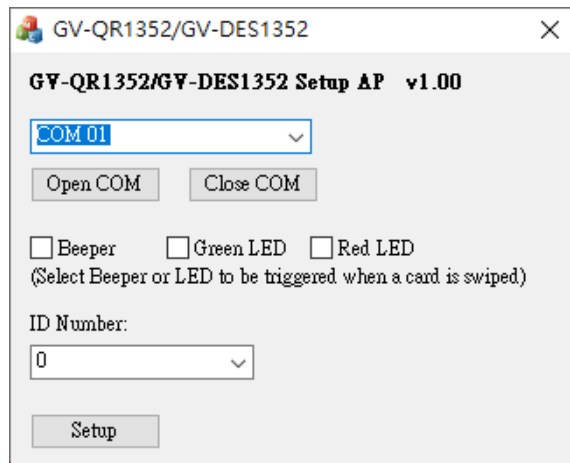

2. Select the COM port that is connected to the reader and click **Open COM**. The red square next to the COM port box should change to blue to indicate the COM port is correct.
3. By default, the beeper is enabled on the reader. To change the reader's reaction upon being approached, deselect/select **Beeper**, **Green LED** and/or **Red LED**. For example, if you select both Beeper and Green LED, when the reader is approached, it will beep together with a flashing green LED.
4. Only for a RS-485 reader, select an **ID number** for the reader. The ID number ranges from 0 to 7.
5. Click **Setup**. The settings are sent to the reader.
6. Connect another reader to the computer, and follow the instructions above for setup.

Note:

1. If the COM port is incorrect, an “**Error opening serial port**” message will appear. To verify the COM port connected to the reader, go to Windows Device Manager. In the Ports (COM & LPT) field, you should see the entry for **Prolific USB-to-Serial Comm Port** and the COM number currently in use.

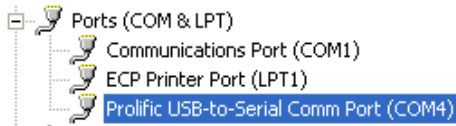

2. By default, the reader has the following access reactions. If you change default beep sounds to *green LED* using the setup app, it will react as below:

For *RS-485* readers,

- One beep when a card / QR code approaches (default) → Flashing green LED when a card / QR code approaches
- Another one beep with green LED upon access granted
- Another two beeps with red LED upon access denied

For *Wiegand* readers,

- One beep upon access granted (default) → Flashing green LED upon access granted
- One beep upon access denied (default) → Flashing green LED upon access denied

1.7 Activate Beeper or LED upon Controller's Output

Trigger

You can set the controller to trigger the reader's red LED, green LED or beeper upon controller's output trigger, such as access granted, access denied and when the specified alarm event occurs. For this, you need to complete the following two steps:

Step 1: Wire the LED and/or beeper to the outputs on the controller. See *section 1.6.1*.

Step 2: Define the output condition to be triggered on the controller's Web interface. See *section 1.6.2*.

1.7.1 Wiring

By the wiring, you can change the following default settings of beeper and LED reactions upon access granted and denied.

With *RS-485* connection to the controller,

- One beep when a card / QR code approaches
- Another one beep with green LED upon access granted
- Another two beeps with red LED upon access denied

With *Wiegand* connection to the controller,

- One beep upon access granted
- One beep upon access denied

For example, you can add LED flashing for *Wiegand* readers, green LED along with beep upon access granted and red LED along with beep upon access denied, by wiring the two LED cables to the controller's outputs.

Wiring LED to GV-AS Controller

The diagram below shows the connection for wiring Green LED using GV-AS410 as an example. For Red LED, wire the orange cable to another output.

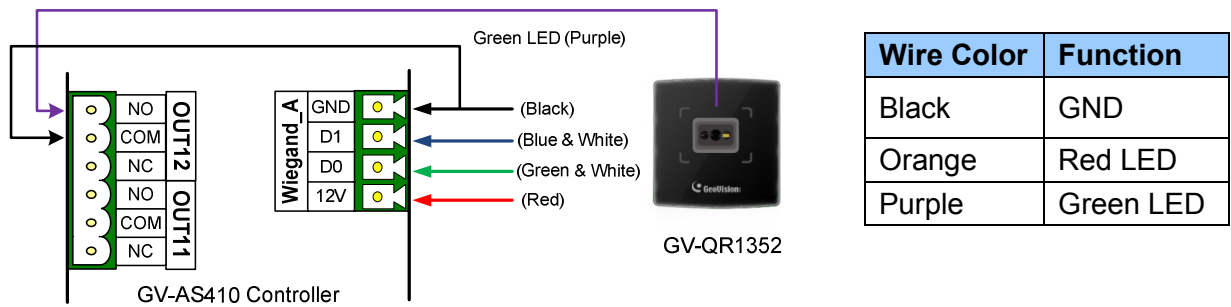

Wiring Beeper to GV-AS Controller

The diagram below shows the connection for wiring the beeper using GV-AS410 as an example.

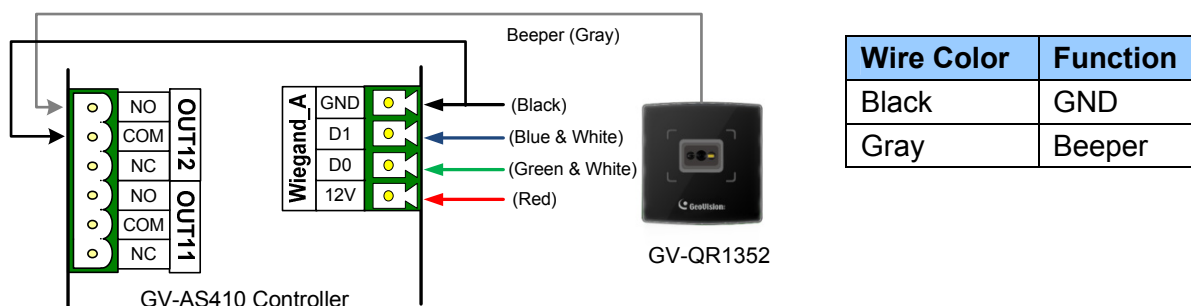

Note: The beeper and LED cables can be wired onto the same output. In this case, the reader will beep along with a flashing LED according to access conditions.

1.7.2 Define Output Conditions

After wiring the beeper or LED, specify the conditions to trigger the beeper or LED on the GV-AS Controller's Web interface. Here we use GV-AS210 Web interface as an example.

1. On the controller Web interface, click **Output Setting**. This page appears.

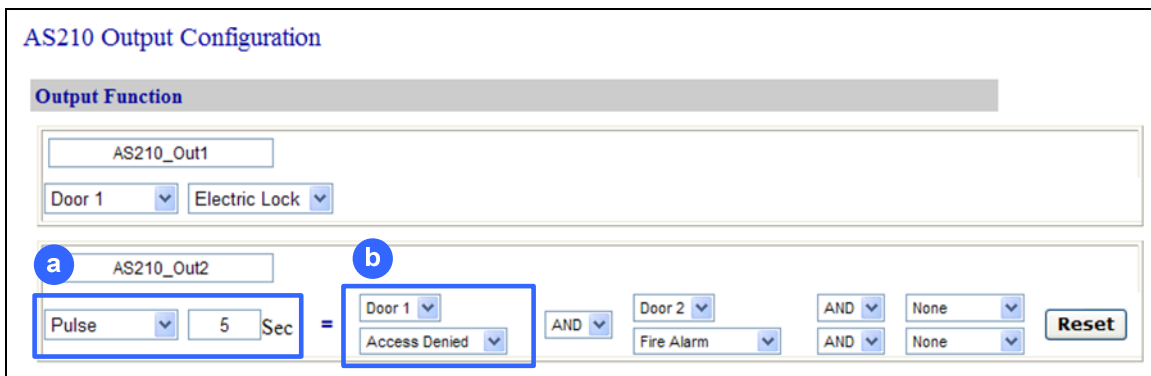

AS210 Output Configuration

Output Function

AS210_Out1
Door 1 Electric Lock

a AS210_Out2 **b**

Pulse 5 Sec = Door 1 Access Denied AND Door 2 AND None AND Fire Alarm AND None **Reset**

2. Find the output wired to the beeper or LED and set up the alarm condition (Access Granted or Access Denied) to set off the beeper or LED.
 - a. **Output Type:** Select **Normal**, **Toggle** or **Pulse**. If you select Pulse, you can specify the number of seconds to trigger the beeper or LED.
 - b. **Output Condition:** Select the door and the alarm condition to trigger the beeper or LED.
3. Click **Submit**.

4. You also need to set up corresponding alarm conditions, e.g., Access Denied, for GV-ASManager to trigger the outputs on the controller. In the Controller Setup dialog box of GV-ASManager, select the door the reader is associated to > the **Advanced** tab, and select corresponding alarm conditions.

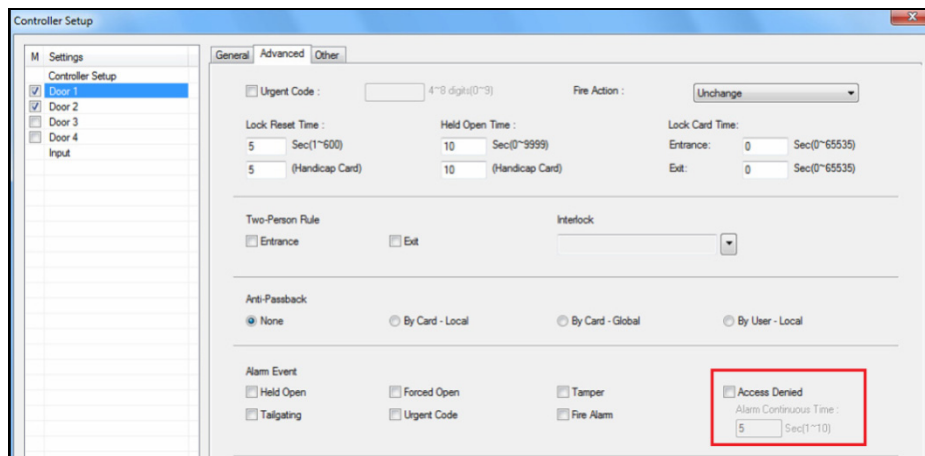

1.8 The Number of Readers Supported by Controllers

GV-AS Controller Model	Number of GV-QR1352 Readers Supported	
	Wiegand	RS-485
GV-AS210 / 2110 / 2120	4	8
GV-AS410 / 4110 / 4111	8	8
GV-AS810 / 8110 / 8111	8	Not supported
GV-AS1620	2	2

GV-AS Controller Model	Number of GV-DES1352 Readers Supported	
	Wiegand	RS-485
GV-AS210 / 2110 / 2120	4	8
GV-AS410 / 4110 / 4111	8	8
GV-AS810 / 8110 / 8111	8	Not supported
GV-AS1620	2	2

Chapter 2 Mobile Cards and Mobile App

GV-ASManager access control system allows users to unlock doors with their smartphones. The *GeoVision mobile access solution* is carried out with virtual access card **GV-Mobile Card**, QR code reader **GV-QR1352** and **GV-Mobile Access app**.

The mobile card can be regarded as a virtual access card. Every mobile card, like a physical access card, represents a unique identification. The administrator edits access credentials for each mobile card using GV-ASManager, and issues it to a user using GV-Mobile Access app. For security reasons, GV-ASManager will not be able to re-issue the same mobile card if the user loses the phone containing the mobile card or deletes the card from the phone.

To begin, you must first acquire GV-Mobile Cards from GeoVision and then download them to GV-ASManager through Internet. The administrator of GV-ASManager then sends verification e-mails to users in order for them to activate the assigned mobile cards on their smartphones. Users can use dynamic QR codes created on the mobile app to unlock matching doors once the mobile cards have been activated.

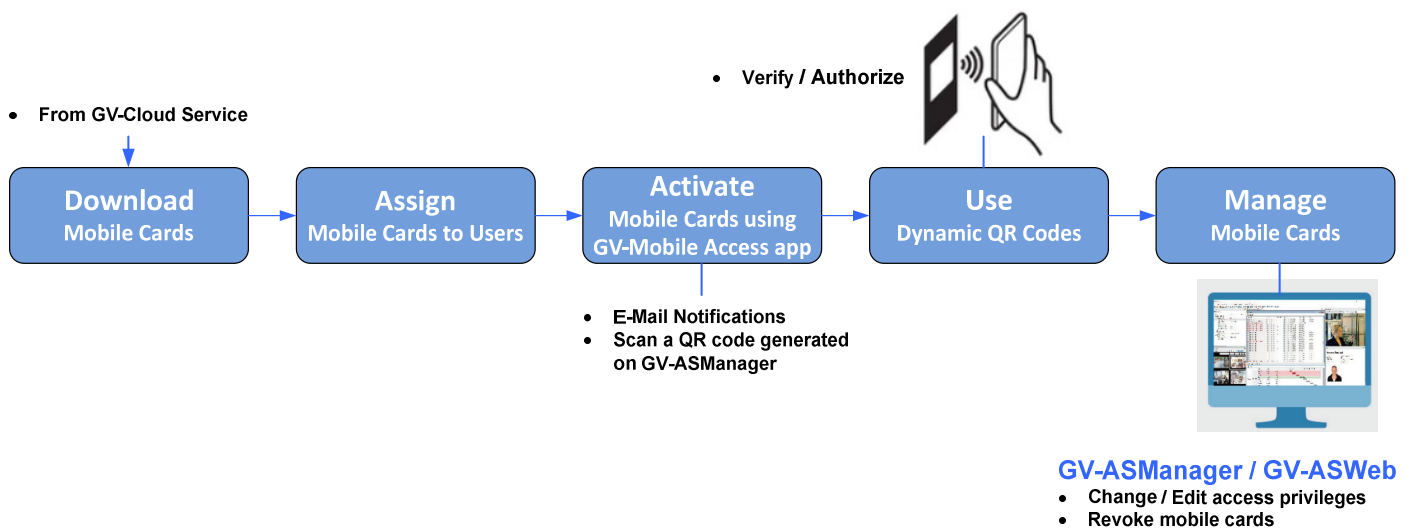

2.1 Download Mobile Cards

You will receive a serial key for the mobile cards you purchased from GeoVision. Use the serial key to download the mobile cards to GV-ASManager.

Note: To download mobile cards from GeoVision Cloud Server, your GV-ASManager server must have Internet access.

1. On the menu bar of GV-ASManager, click **Personnel > Cards**.

2. On the Card List, click **Mobile Card**  > **Assign Mobile Card**.

3. Select **Dispatch Mobile Card**.

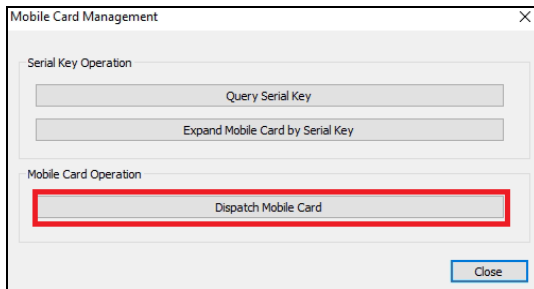

4. You are requested to type the serial key of the mobile cards purchased. Click **OK**.

5. Select the desired mobile cards to be downloaded to and be dispatched by the GV-ASManager, and click **Dispatch**.

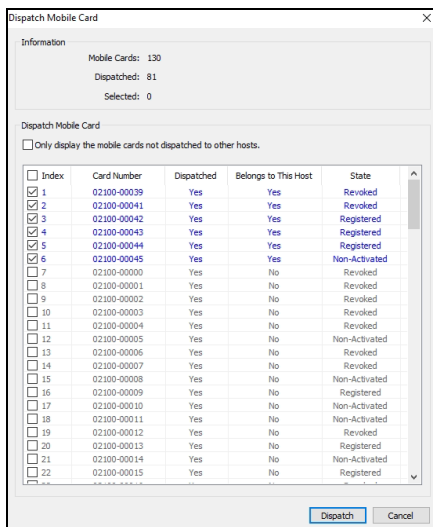

Note: The Dispatch Mobile Card dialog box provides the information of how many mobile cards contain for a serial key and how many mobile cards have been downloaded to and dispatched by the GV-ASManager.

6. The Card List may look like this. The mobile cards downloaded display a “Non-Activated” status.

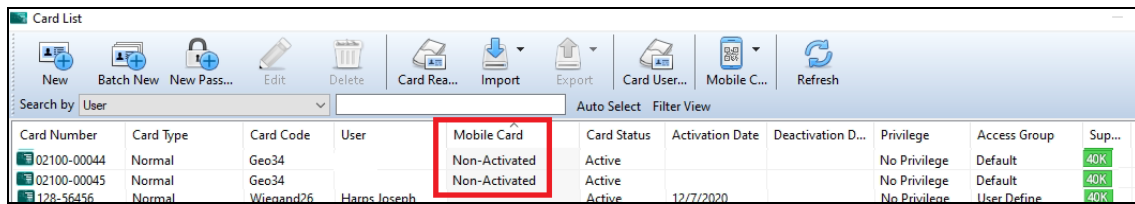

Card Number	Card Type	Card Code	User	Mobile Card	Card Status	Activation Date	Deactivation D...	Privilege	Access Group	Sup...
02100-00044	Normal	Geo34		Non-Activated	Active			No Privilege	Default	40K
02100-00045	Normal	Geo34		Non-Activated	Active			No Privilege	Default	40K
128-56456	Normal	Wiegand26	Harps Joseph		Active	12/7/2020		No Privilege	User Define	40K

Note:

1. More than one GV-ASManager server can use the same serial key to download and dispatch mobile cards. Once a mobile card is downloaded, it cannot be downloaded by another GV-ASManager.
2. You can use *Export* to and *Import* from Excel functions to export the mobile cards and import them to another GV-ASManager for card management.



Card Number	Card Type	Card Code	User	Mobile Card	Card Status	Activation Date	Deactivation Date	Privilege	Access Group	Sup...
02100-00042	Normal	Geo34		Non-Activated	Active			No Privilege	Default	40K
02100-00043	Normal	Geo34		Active	Active			No Privilege	Def	
02100-00044	Normal	Geo34		Active	Active			No Privilege	Def	
02100-00045	Normal	Geo34		Active	Active			No Privilege	Def	
128-56456	Normal	Wiegand26	Harps Joseph	Active	Active	12/7/2020		No Privilege	Use	
242-51118	Normal	Wiegand26	Harps Joseph	Active	Active			No Privilege	Use	
123-45678	Visitor	Wiegand26		Inactive	Inactive	8/18/2020		No Privilege	Def	
000-00000	Normal	Wiegand26		Active	Active			No Privilege	Use	

2.2 Assign Mobile Cards to Users

To assign a mobile card to a user, follow the procedures below. You can assign more than one mobile card to a user.

1. On the Card List, click one “Non-Activated” mobile card and select **Edit**.

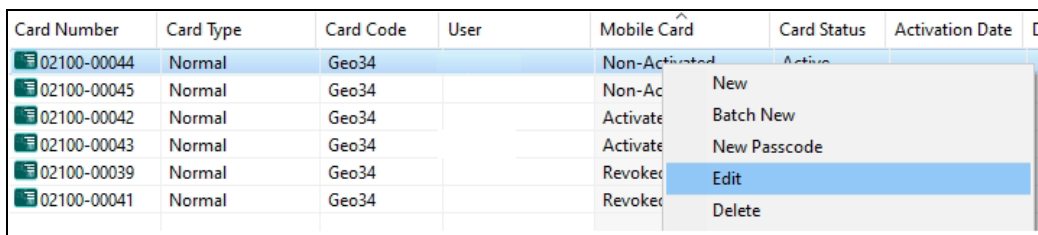

Card Number	Card Type	Card Code	User	Mobile Card	Card Status	Activation Date	D
02100-00044	Normal	Geo34		Non-Activated	Active		
02100-00045	Normal	Geo34		Non-Ac			
02100-00042	Normal	Geo34		Activate			
02100-00043	Normal	Geo34		Activate			
02100-00039	Normal	Geo34		Revoked			
02100-00041	Normal	Geo34		Revoked			

- On the Edit Card dialog box, click the **User** button > **Assign a new user**.

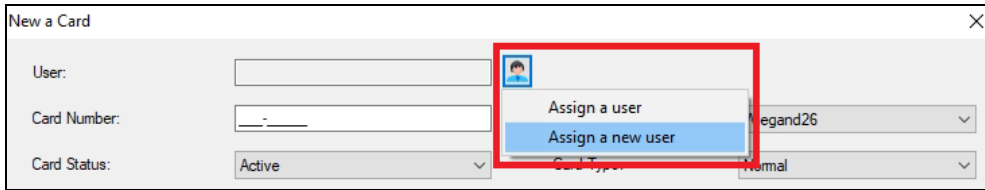

- Under **Employee ID**, optionally type an ID which will be used as the verification code to open the mobile card on the mobile app.

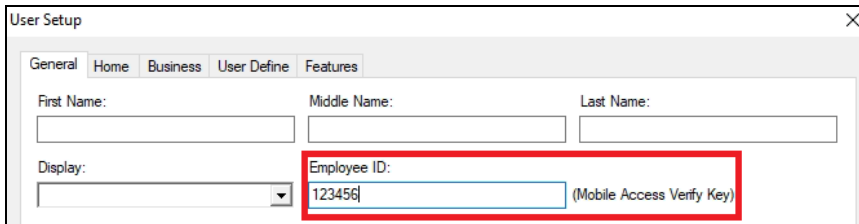

- Under the **Business** tab, type the **E-Mail Address** of the user which will be used to send the notification for activating the assigned mobile card.

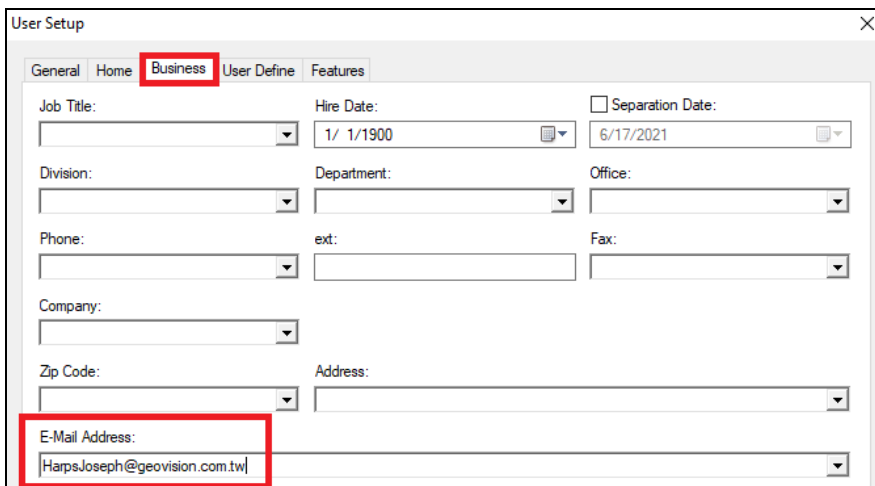

- Fill out other necessary information of the user on the User Setup dialog box, and click **OK**.
- On the Edit the Card dialog box, select the controller and the door to which the reader is connected, and select 24-hour access or assign the access schedule of a predefined Access Group. And click **OK**.

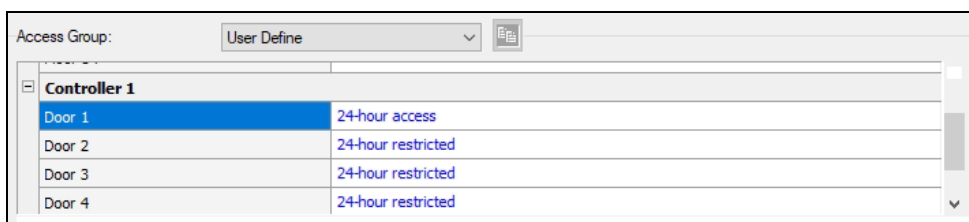

Note: For details on creating a User and an Access Group, see [4.5 Setting Access Groups](#) and [4.6 Setting Users](#), respectively in [GV-ASManager User's Manual](#).

2.3 Activate Mobile Cards

The user has two methods to activate the assigned mobile card.

1. Through e-mail notifications to activate the mobile card on a smartphone
2. Scan a dynamic QR code generated by and on the GV-ASManager. For this, the user needs to install the mobile app first and scan the QR code with the mobile app to activate the mobile card.

Note:

1. For GV-ASManager to send e-mail notifications, it is required to set up the mail sever in advance. For details, see [8.2.2 Setting E-Mail Server in GV-ASManager User's Manual](#).
 2. The administrator can also use GV-ASWeb to send e-mail notifications or create a dynamic QR Code for the user to activate the assigned mobile card.
-

2.3.1 Through E-Mail

1. On the Card List, select the desired mobile card, click the **Mobile Card** button > **Send Mail**.
2. Open the e-mail notification on your smartphone and follow the instructions mentioned within to download the mobile app, or click the verification link to open the installed mobile app directly.
3. Once succeeded, a prompt for entering a verification code appears. If you have set up an **employee ID** for the User (see Step 3, [2.2 Assign Mobile Cards to Users](#)), enter the ID at this step. If not, click **OK** to skip the step.

- The mobile card has been added to the mobile app now. Double-click it to generate a dynamic QR code and use the QR code to gain access to its corresponding door.

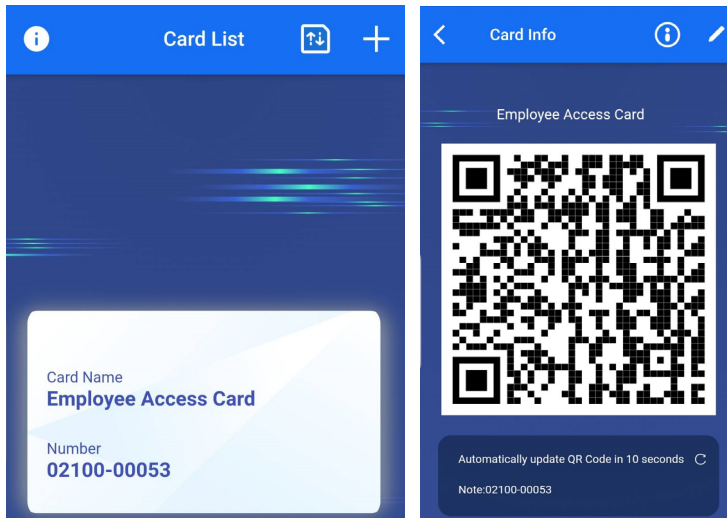

Once the mobile card is activated on a smartphone, the status of the mobile card on GV-ASManager will change from “Non-activated” to “Activated”.

Note: If the status of the mobile card does not change on the Card List accordingly, click the **Mobile Card** button > **Sync Status**.

2.3.2 Scan a QR Code on GV-ASManager

- On the Card List, select the desired mobile card, click the **Mobile Card** button > **Show Activate QR Code**.

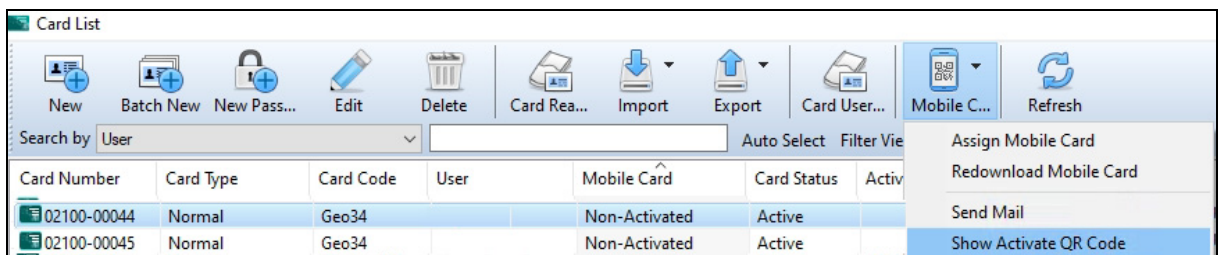

- Open GV-Mobile Access app, click + on the right top > **QR Code Scan**.
- Point the mobile camera towards the QG code generated on GV-ASManager.
- Once succeeded, a prompt for entering a verification code appears. If you have set up an employee ID for the User (see Step 3, 2.2 *Assign Mobile Cards to Users*), enter the ID at this step. If not, click **OK** to skip the step.

5. The mobile card has been added to the mobile app now. Double-click it to generate a dynamic QR code and use the QR code to gain access to its corresponding door. Refer to the illustrations on Step 5, *2.3.1 Through E-Mail*.

Once the mobile card is activated on a smartphone, the status of the mobile card on GV-ASManager will also change from “Non-activated” to “Activated”.

Note: If the status of the mobile card does not change on the Card List accordingly, click the **Mobile Card** button > **Sync Status**.

2.4 Mobile Card Managements

2.4.1 Query and Combine Serial Keys

When you have more than one serial key, you can check the content of each serial key, and combine them all on one GV-ASManager. On the Card List, click the **Mobile Card** button on the toolbar > **Assign Mobile Card** to open the following Mobile Card Management window.

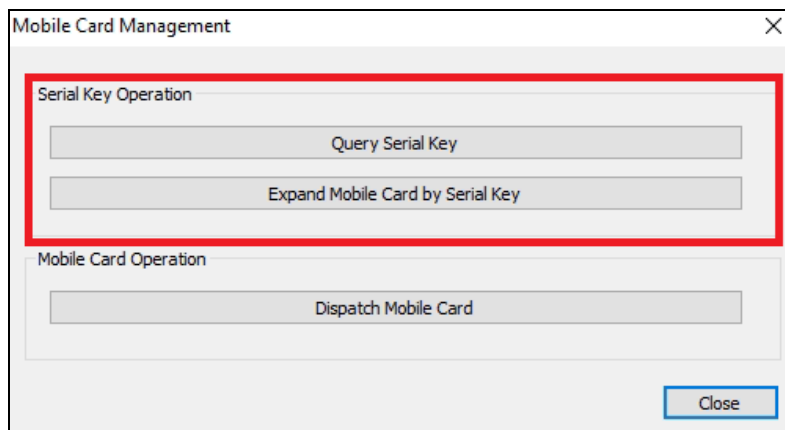

Query Serial Keys

1. On the Mobile Card Management window, select **Query Serial Key**.
2. You are prompted to enter a serial key.
3. Click **OK**. You will see the content of the serial key.

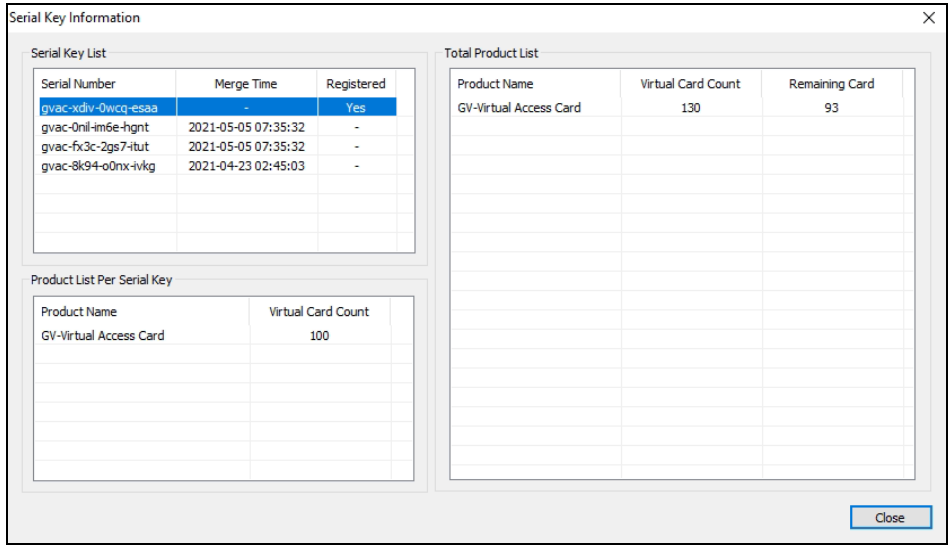

Combine Serial Keys

1. On the Mobile Card Management window, select **Expand Mobile Card by Serial Key**.
2. You are prompted to enter a new serial key.
3. Click **OK**. You will see the content of the new serial key is combined with that of the serial key already used on GV-ASManager.

2.4.2 Revoke Mobile Cards

When revoked, the mobile card cannot be used for gaining access and cannot be dispatched to another user again. To revoke a mobile access card, on the Card List, click the **Mobile Card** button on the toolbar > **Revoke**.

2.5 GV-Mobile Access App

GV-Mobile Access app contains the mobile cards, aka virtual cards, assigned to a user; then the user can use the smartphone with the app to unlock corresponding doors.

System requirements and Specifications

OS Supported	iOS 11 or later
	Android 8 or later
System Supported	GV-ASManager V5.3.3 or later
Functions	<ul style="list-style-type: none"> ● Contain up to 10 mobile cards ● Generate <i>dynamic QR codes</i> for each mobile card, and the dynamic QR codes will change every 10 seconds

2.5.1 Edit the Card

You can modify the card name, put a note for a card, and set a card as your default card to open its dynamic code once the app is executed.

1. Double-click a mobile card on the app. Its dynamic QR code appears.
2. Click the  icon on the top right.

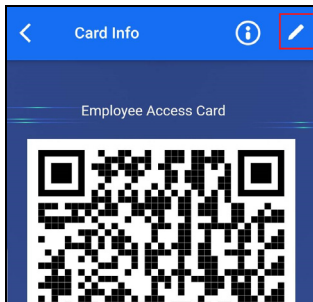

3. Edit the card name, add a note (which will be displayed under the dynamic QR code) or set the card as your default card. Click **Done**.

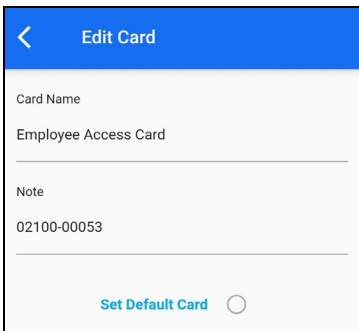

2.5.2 Backup and Restore

You can transfer the mobile cards from one smartphone to another. Please note the transfer will delete all the mobile cards from a smartphone.

1. Open the mobile app, click  on the top right. This page appears.

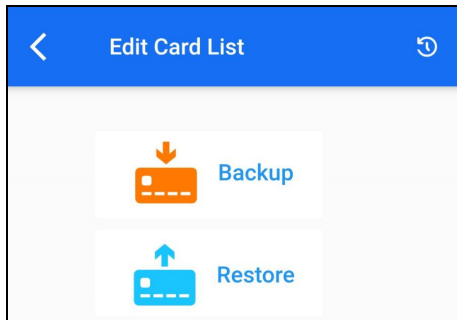

2. Click **Backup** to export the mobile cards.
3. Type a password to be used for opening the exported data on another smartphone. Click **Done**.
4. A QR code appears to represent the exported data.
 - Click **Save** to save the QR code image on the smartphone. Or,
 - Click **Done**. You can open the QR code of exported data later by clicking the  icon on the right top.

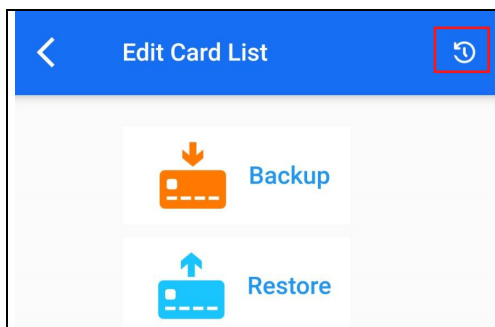

5. On another smartphone, click **Restore** to import the mobile cards.
 - Click **Open Gallery** to locate and open the QR code of exported data. Or,
 - Click **Open camera to scan QR code** to scan the QR code of exported data.

Chapter 3 Visitor QR Codes

GV-QR1352 can identify two types of visitor QR codes. One is the QR code issued by *GV-ASManager Visitor Management System (GV-VMWeb)*. The other is the QR code created by *GV-Mobile Access app* from a mobile card.

Note: To create visitor QR codes using *GV-VMWeb*, refer to *Chapter 12 GV-VMWeb for Visitor Management* in [GV-ASManager User's Manual](#)

When a mobile card is set for “Visitor” use, the administrator can manage it by defining the validity period of each QR code, sharing its QR code to a visitor from the phone, as well as regenerating a new QG code for the next visitor.

The Visitor mobile card function is only compatible with certain products and versions. See *1.2 Compatible Products* for details.

To create Visitor Mobile Card on GV-ASManager:

1. Follow the steps in *section 2.1* and *2.2* to download mobile cards and assign mobile cards to users.
2. When assigning mobile cards to users, select **Visitor** under Card Type.

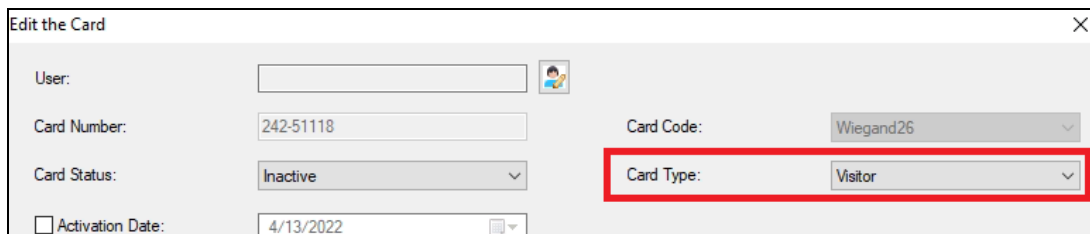

The screenshot shows a dialog box titled "Edit the Card" with a close button (X) in the top right corner. The dialog contains several input fields and dropdown menus:

- User:** An empty text input field with a user icon to its right.
- Card Number:** A text input field containing the value "242-51118".
- Card Status:** A dropdown menu with "Inactive" selected.
- Card Code:** A dropdown menu with "Wiegand26" selected.
- Card Type:** A dropdown menu with "Visitor" selected. This field is highlighted with a red rectangular box.
- Activation Date:** A date input field with a calendar icon, containing the value "4/13/2022".

3. Follow the steps in *section 2.3* to activate mobile cards.

To regulate Visitor Mobile Card on GV-Mobile Access app:

- 4. Follow the steps in *section 2.3* to activate mobile cards.
- 5. When you open the Visitor mobile card for the first time, you will be prompted to set up the validity period of the QR code.

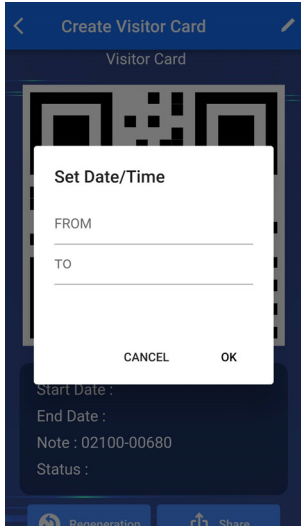

- 6. Click **Share** to send the created QR code to a user. Or click **Regeneration** to renew the QR code with a different validity period.



QR Code Comparison

The following two types of QR codes can be read by GV-QR1352.

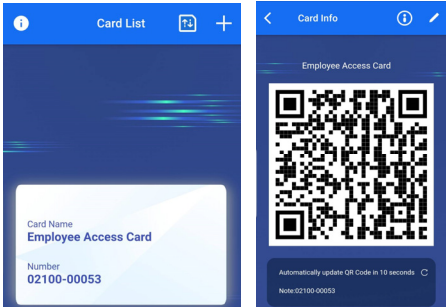
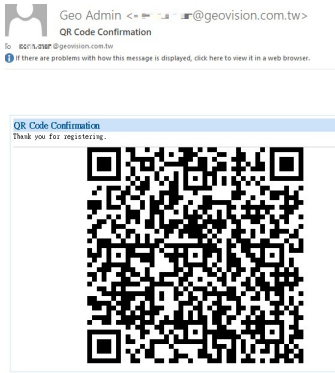
Type	Mobile Access QR Code	Visitor QR Code of GV-VMWeb
Application	Regular or Visitor access control	Visitor access control
Features	GV-ASManager sends a mobile card to a user's phone, and GV-Mobile Access app generates a QR code to represent the mobile card.	The QR code is issued by GV-ASManager Visitor Management System (GV-VMWeb).
	A user receives an e-mail to activate the mobile card using GV-Mobile Access app.	A visitor receives a QR code in a confirmation e-mail of visiting request.
		
	The QR code represents a mobile card, a unique ID.	The QR code represents a virtual visitor card, a unique ID.
	Regular Access: Dynamic QR code changed every 10 sec. Visitor Access: Static QR code with defined access period	Static and single-use QR code
GV-QR1352 Connection	Only RS-485, with compatible GV-AS210 / 2110 / 2120, GV-AS410 / 4110 / 4111, GV-AS1620 versions	RS-485 and Wiegand
Charge	Needed	Free of charge

Troubleshooting

Q1: What is the verification code on the mobile app?

The verification code is the *employee ID* set for a user on GV-ASManager (see Step 3, 2.2 *Assign Mobile Cards to Users*). The employee ID is an optional setting. If the administrator does not set up an employee ID, just skip the request of verification code on the mobile app. But for security reasons, it is recommended to set up an employee ID, verification code, to open the assigned mobile card.

Q2: I did not receive the activation e-mail or it has expired.

The activation e-mails expire 72 hours after they are sent. If a user does not receive the e-mail or it has expired, the administrator of GV-ASManager can send a new activation e-mail.

Q3: I deleted the mobile card / the app or lost my phone.

Once the mobile cards are activated on the app, for security reasons, the same cards cannot be re-issued by GV-ASManager. The administrator can deactivate the lost cards and issue new cards.

Q4: I got a new phone, and how to do with the mobile cards?

Users can transfer the mobile cards from one phone to another by using the Backup and Restore function in the app. See 2.5.2 *Backup and Restore* in the manual.

Q5: Why does the Apple Pay pop up when scanning QR code towards the reader?

To avoid this scenario, it is recommended to keep a distance of 10-15 cm (4-6 in) from the reader for effective scanning.

Q6: How many mobile cards can GV-Mobile Access app contain?

Up to 10 mobile cards

Q7: Can the mobile cards be re-downloaded to GV-ASManager?

Yes, if the administrator removes the mobile cards from GV-ASManager, on the Card List, click the **Mobile Card** button on the toolbar > **Redownload Mobile Card**.